



# **D/N ATR 700TVL VARI-FOCAL IR CAMERA**

**CMR7384X/7388X10 N/P**

**INSTRUCTION MANUAL**

## IMPORTANT SAFEGUARDS

### 1. Read Instructions

All the safety and operating instructions should be read before the unit is operated.

### 2. Retain Instructions

The safety and operating instructions should be retained for future reference.

### 3. Read Warnings

All warnings on the unit and in the operating instructions should be adhered to.

### 4. Follow Instructions

All operating and user instructions should be followed.

### 5. Electrical Connections

Only a qualified electrician should make electrical connections.

### 6. Attachments

Do not use attachments not recommended by the product manufacturer as they may cause hazards.



### 7. Cable Runs

All cable runs must be within permissible distance.

### 8. Mounting

This unit must be properly and securely mounted to a supporting structure capable of sustaining the weight of the unit.

## SAFETY PRECAUTIONS

 <b>CAUTION</b>  <b>RISK OF ELECTRIC SHOCK</b>
<b>CAUTION :</b> TO REDUCE THE RISK OF ELECTRIC SHOCK, DO NOT OPEN COVER. NO USER SERVICEABLE PARTS INSIDE. REFER SERVICING TO QUALIFIED SERVICE PERSONNEL.



The lightning flash with arrowhead symbol, within an equilateral triangle, is intended to alert the user to the presence of uninsulated "dangerous voltage" within the product's enclosure that may be of sufficient magnitude to constitute a risk of electric shock to persons.



The exclamation point within an equilateral triangle is intended to alert the user to the presence of important operating and maintenance (servicing) instructions in the literature accompanying the unit.

## UNPACKING

Unpack carefully. Electronic components can be damaged if improperly handled or dropped. If an item appears to have been damaged in shipment, replace it properly in its carton and notify the shipper.

Be sure to save:

1. The shipping carton and packaging material. They are the safest material in which to make future shipments of the equipment.
2. This Installation and Operating Instruction.

## SERVICE

If the unit ever needs repair service, the customer should contact our dealer or branch for authorization to return and shipping instructions.



# Part Description & Dimension

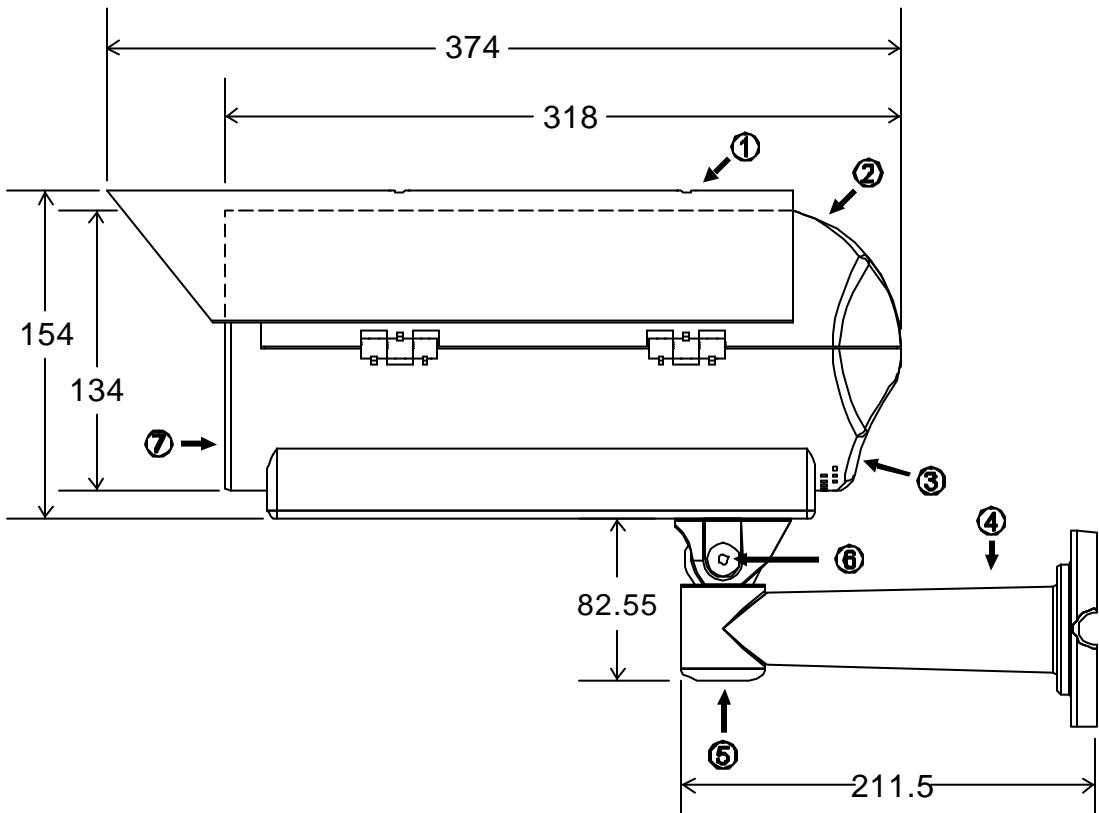

Unit : mm

- ① SUN SHIELD
- ② TOP COVER
- ③ BOTTOM CHASSIS
- ④ BRACKET
- ⑤ PAN ADJUSTMENT SCREW
- ⑥ TILT ADJUSTMENT SCREW
- ⑦ WINDOW

# INSTALLATION

1. Take out the bracket from the box first. Put the power cable and video cable through the bracket and then fix it to the wall (FIG.1 & FIG.2).

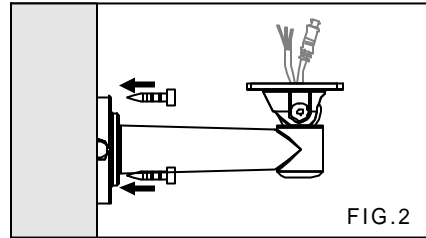
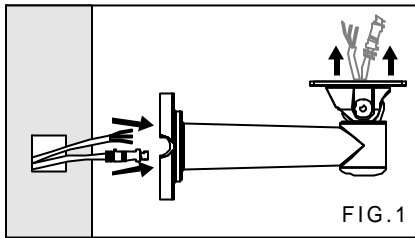

2. Secondly, take out the camera body and open the top cover with hexagon screw driver (FIG.3 & FIG.4).

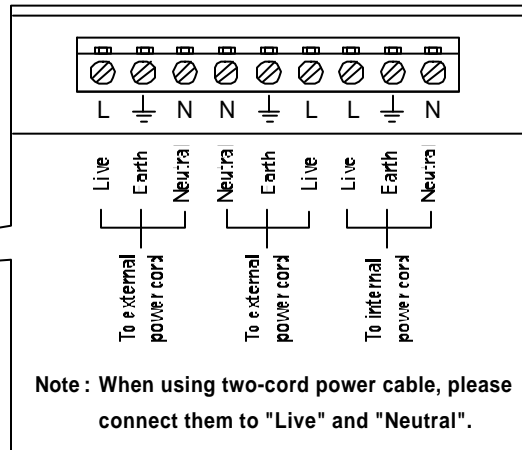
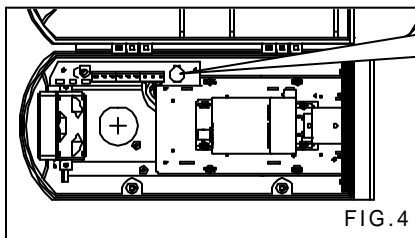
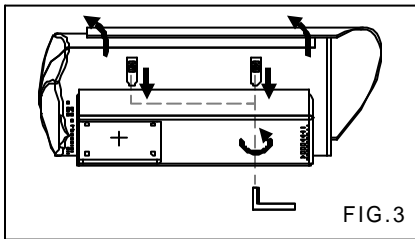

3. Put the power cable and video cable through the bracket rubble first and then go through the bottom of camera body (FIG.5). Plug and fix the power cable to the terminal and plug the video cable to video output of the camera (FIG.6).

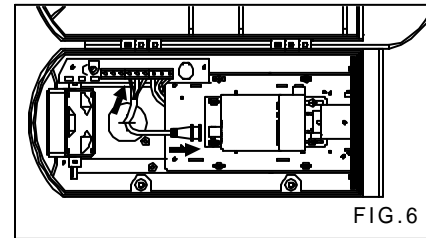
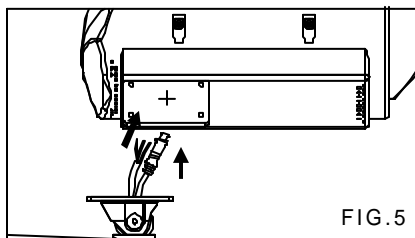

Next, use the provided 1/4"-20UNC screws (silver-4pcs) to fix the camera body on the bracket with hexagon screw driver (FIG.7).

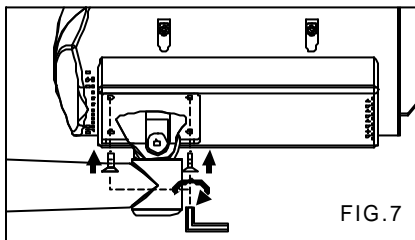

FIG.7

4. Loosen the pan and tilt adjustment screw on the bracket to turn the camera body to the desired angle and then tighten the screw (FIG.8).

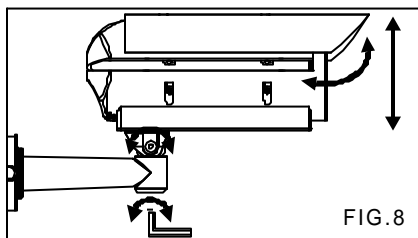

FIG.8

5. First, adjust the lens on focus and zoom to form the optimal video image after that tighten the screws (FIG.9). Then adjust the OSD menu. Please refer to page5 ~page16.

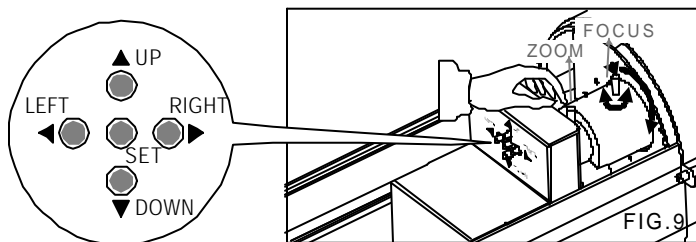
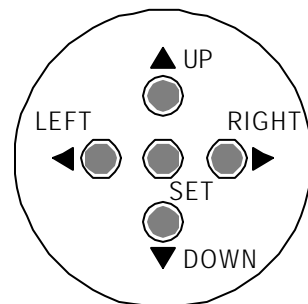



FIG.9

### 5-1. USER OSD SETTING

Setting switches and Functions.

- A. ▲ (UP) : Press to move the cursor upwards or to select items.
- B. ◀ (LEFT) : Press to move the cursor to the left and to select or adjust the parameters of the selected item. The parameters changes each time this button is pressed.



- C. ► (RIGHT) : Press to move the cursor to the right and to select or adjust the parameters of the selected item.  
The parameters changes each time this button is pressed.
- D. ▼ (DOWN) : Press to move the cursor downwards or to select items.
- E. SET : Executes selections and displays a submenu for an item with the  mark.

6. Adjust VR1 to set Infrared LED activation level (FIG.10). Turn the VR1 toward "MAX" to higher the Infrared LED activation Lux level and vice versa.

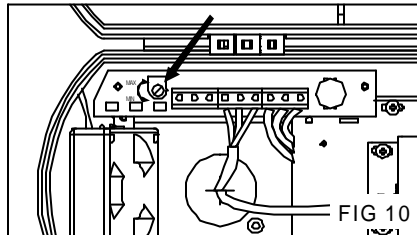

7. Replace the top cover and tighten the screws (FIG.11 & FIG.12).

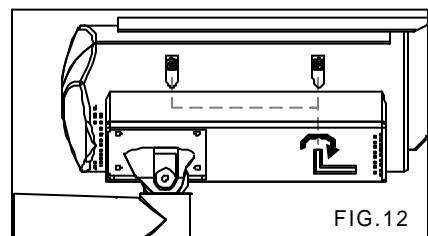
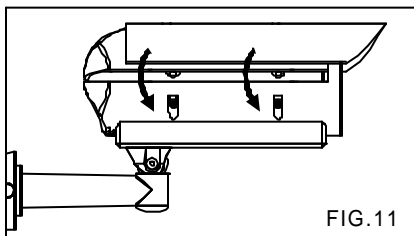

# CONFIGURATION OF THE MENU

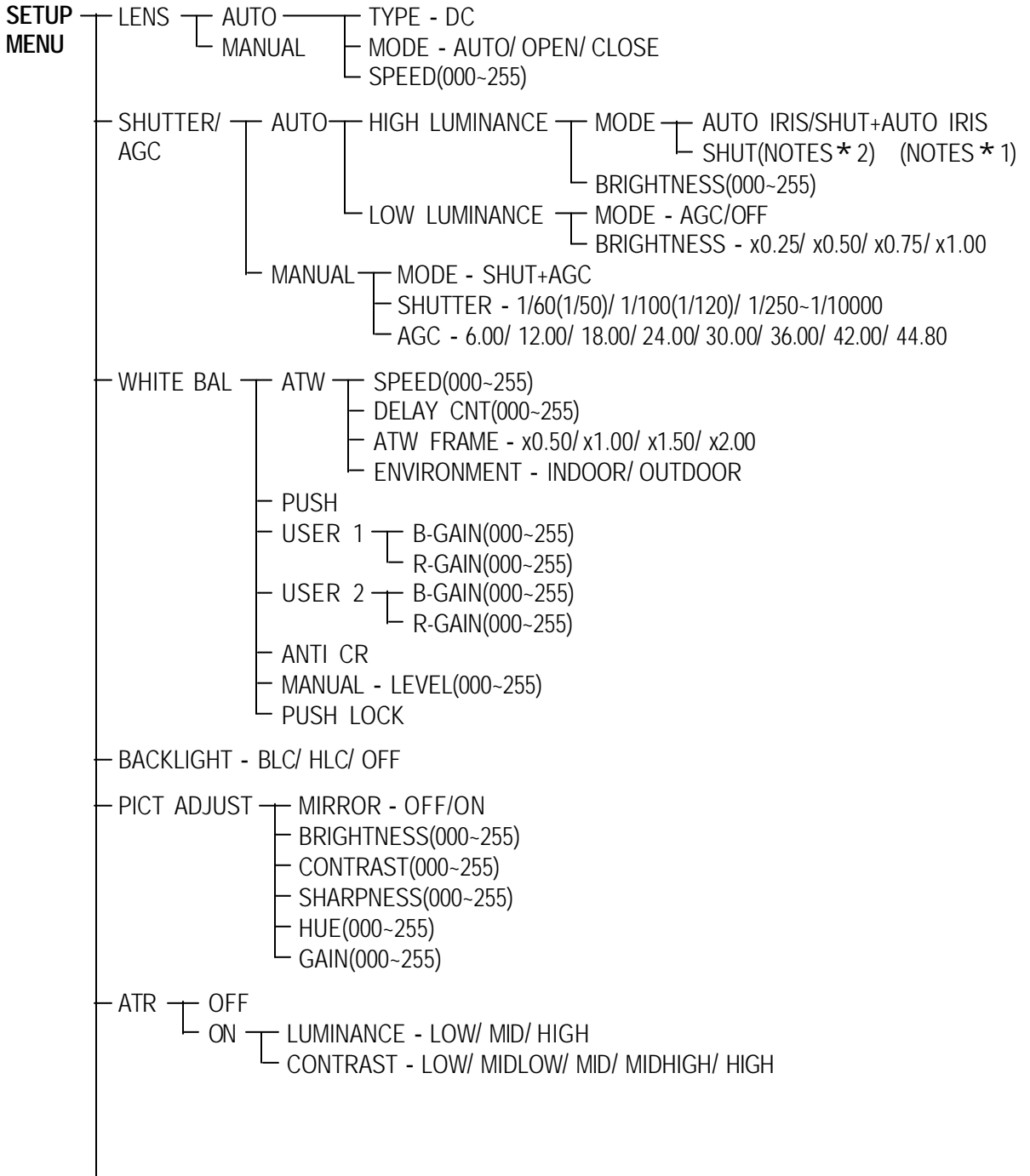

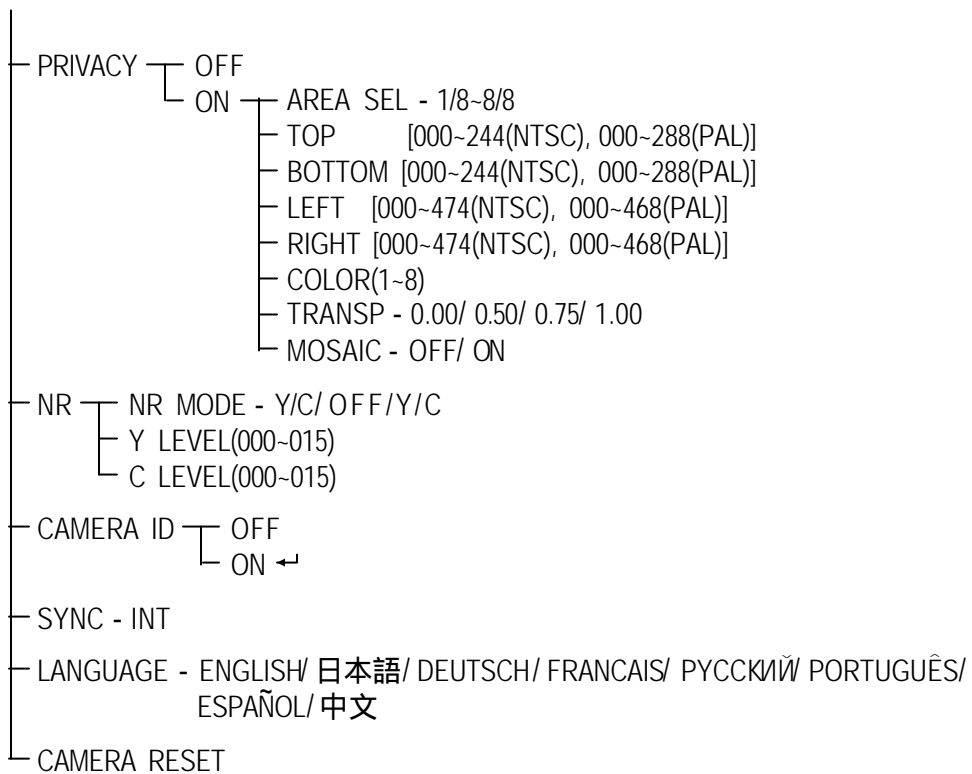

### NOTES

- \* 1: Set the LENS mode to AUTO on the SETUP MENU menu.
- \* 2: Set the LENS mode to MANUAL on the SETUP MENU menu.

# SETTING MENU AND FUNCTIONS

## TO Open and Exit the Menu screen

1. Press "SET" button.  
The Menu screen appears on the monitor. Check the current settings on the menu.
2. Push ▲ or ▼ button to select the options then use ◀ or ▶ button to select a mode.
  - NEXT: To the next setup menu.
  - BACK: Return to the previous.
  - RETURN: Return to the previous.
  - SAVE ALL: Used to save the various setting of the internal OSD menu in the EEPROM together.
  - EXIT: Exit the setup menu.

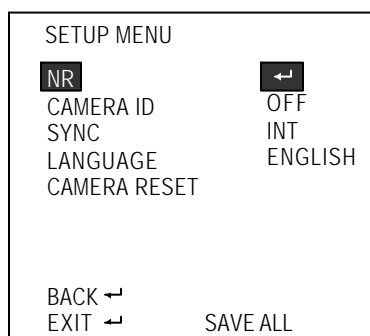
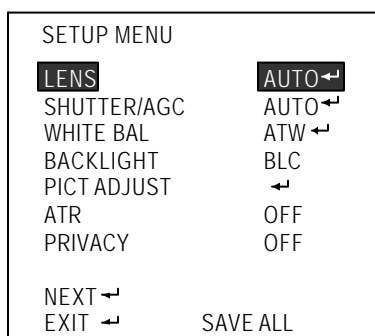

## LENS

This function is used to set the mechanical iris of the lens.

1. Select [LENS] option.
2. Push ◀ or ▶ button to select a mode.

LENS mode changes as follows:

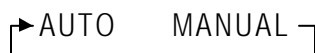

AUTO: Select the auto iris lens.

MANUAL: Select the manual iris lens.

3. Select an AUTO then press "SET" button.  
The AUTO IRIS menu appears.

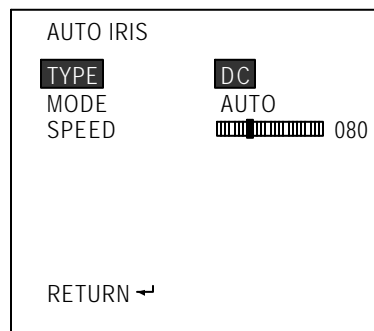

- AUTO (AUTO IRIS)

FUNCTION	OPTION	DESCRIPTION
TYPE	DC	Sets the type of mechanical iris. DC: Direct drive signal.
MODE	AUTO OPEN CLOSE	Sets the type of control to be exercised over the mechanical iris. AUTO: The mechanical iris is controlled automatically. OPEN: The mechanical iris is fixed to open. CLOSE: The mechanical iris is fixed to close.
SPEED	000~255	Sets the convergence speed of the mechanical iris.

**NOTE**

Only DC mode on the TYPE option. Because a DC auto iris lens is used with this camera.

## SHUTTER/AGC

This function is used to set AE(Auto Exposure) or ME(Manual Exposure).

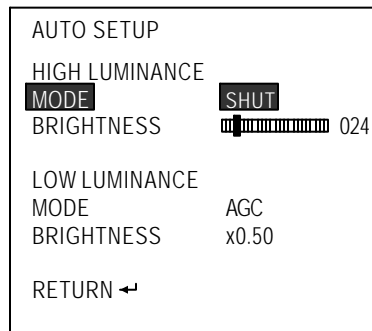
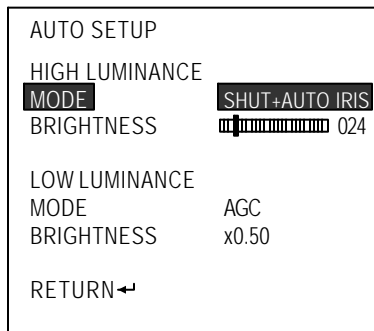

1. Select [SHUTTER/AGC] option.
2. Push◀ or▶ button to select an AUTO or MANUAL then press "SET" button. The AUTO SETUP or MANUAL SETUP menu appears.  
SHUTTER/AGC mode changes as follows:

▶AUTO      MANUAL◀

AUTO: Select the AE control.

MANUAL: Select the ME control.

• AUTO (AE)

FUNCTION		OPTION	DESCRIPTION
HIGH LUMINANCE	MODE	AUTO IRIS SHUT+AUTO IRIS	1. Set the LENS mode to AUTO on the SETUP MENU menu. 2. Specifies AE control on the medium and high brightness side. AUTO IRIS: Fixed electronic shutter. [1/60sec.(NTSC), 1/50sec.(PAL)] SHUT+AUTO IRIS: Auto electronic shutter. [1/60sec.(1/50sec.)~1/100,000sec.]
		SHUT	1. Set the LENS mode to MANUAL on the SETUP MENU menu. 2. Specifies AE control on the medium and high brightness side. SHUT: Auto electronic shutter. [1/60sec.(1/50sec.)~1/100,000sec.]
	BRIGHTNESS	000~255	Specifies the medium and high brightness side reference.
LOW LUMINANCE	MODE	AGC OFF	Specifies AE control on the low brightness side. AGC: AGC ON OFF: AGC OFF
	BRIGHTNESS	x0.25 x0.50 x0.75 x1.00	Specifies the low brightness side reference.

Setting of shutter speed of AUTO IRIS mode

Please set-up proper shutter speed for AUTO IRIS mode as below:

SHUTTER/AGC: AUTO[SETUP MENU] SET MODE: AUTO IRIS[AUTO SETUP]

RETURN SHUTTER/AGC: MANUAL[SETUP MENU] SET SHUTTER:

1/60(1/50) or 1/100(1/120) or 1/250.....[MANUAL SETUP] RETURN SHUTTER/

AGC: AUTO[SETUP MENU] SAVE ALL SET EXIT

- MANUAL (ME)

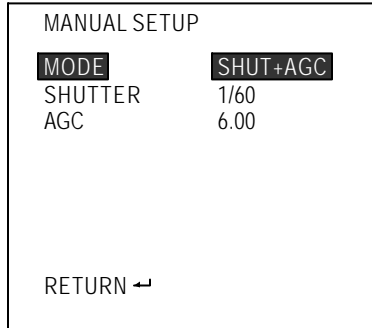

FUNCTION	OPTION	DESCRIPTION
MODE	SHUT+AGC	"SHUT+AGC" is the only option available for the ME operation mode. There are no other options.
SHUTTER	1/60(NTSC), 1/50(PAL) 1/100(NTSC), 1/120(PAL) 1/250 1/500 1/1000 1/2000 1/4000 1/10000	Sets the ME shutter speed(in fractions of a second).
AGC	6.00 12.00 18.00 24.00 30.00 36.00 42.00 44.80	Sets the AGC value(dB) for ME.

**NOTE**

Please select AUTO mode on the SHUTTER/AGC option. If you select MANUAL mode, the over exposure may occur.

## WHITE BAL (WHITE BALANCE)

This function is used to set the white balance operation mode.

1. Select [WHITE BAL] option.
2. Push ◀ or ▶ button to select a mode.

WHITE BAL mode changes as follows:

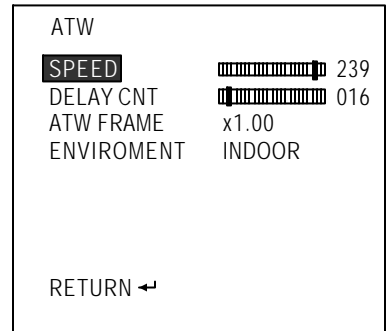

- ATW (Auto Tracking White balance)

This function automatically tracks the changes in the color temperature, and adjusts the white balance.

The color temperatures ranging from 1800K to 10500K.

FUNCTION	OPTION	DESCRIPTION
SPEED	000~255	Adjusts the pull-in speed of ATW.
DELAY CNT	000~255	Sets the time-based hysteresis of ATW.
ATW FRAME	x0.50 x1.00 x1.50 x2.00	Sets the pull-in frame magnification.
ENVIROMENT	INDOOR OUTDOOR	Sets the pull-in frame(indoor/outdoor) of ATW. INDOOR: Select the indoor pull-in frame. OUTDOOR: Select the outdoor pull-in frame.

- PUSH (Full pull-in)

This function adjusts the white balance regardless of the subject conditions.

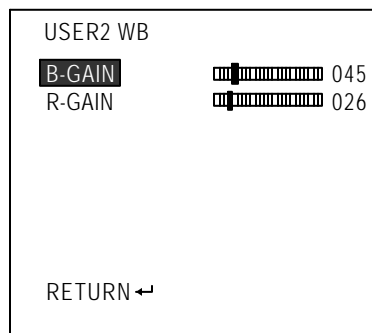
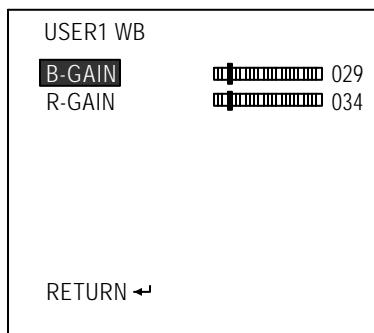

- USER1

The gain values for the outdoor fixed mode are used as the adjustment items of USER1 on the internal OSD menu.

- USER2

The gain values for the fluorescent light fixed mode are used as the adjustment items of USER2 on the internal OSD menu.

FUNCTION	OPTION	DESCRIPTION
B-GAIN	000~255	Used for the B gain operation in the WB fixed gain mode.
R-GAIN	000~255	Used for the R gain operation in the WB fixed gain mode.

- ANTI CR (Color Rolling suppression)

This function minimizes the color changes(color rolling) over long periods caused by very small differences between the flicker frequency of non-inverter fluorescent lights and the drive frequency of the image sensor devices.

- MANUAL (Manual WB)

The B and R gain values for manual WB are set on this screen.

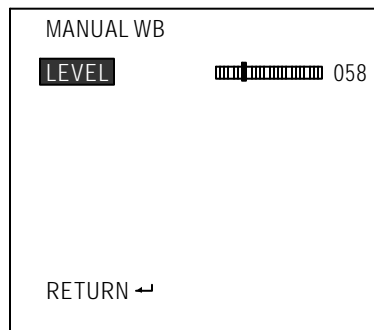

FUNCTION	OPTION	DESCRIPTION
LEVEL	000~255	Sets the B and R gain values for manual WB. By incrementing or decrementing the B gain value, the R gain value is also adjusted in tandem.

- PUSH LOCK (Hold)

The WB gain level established when operation has transferred to the PUSH LOCK mode is held.

1. Push ◀ or ▶ button to select [PUSH LOCK] Mode then press "SET" button.

## BACKLIGHT (BACKLIGHT Compensation)

This function is used to set the backlight compensation operation.

1. Select [BACKLIGHT] option.
2. Push ◀ or ▶ button to select a mode.

BACKLIGHT mode changes as follows:

▶ BLC HLC OFF ◀

BLC: Backlight compensation ON.

HLC: HLC(High Light Compensation) function ON

High Light Compensation(HLC) is a function that improves the visual recognition of license plates and other such objects by suppressing or masking strong light sources(such as the headlights of automobiles) in dark places.

OFF: Backlight Compensation OFF.

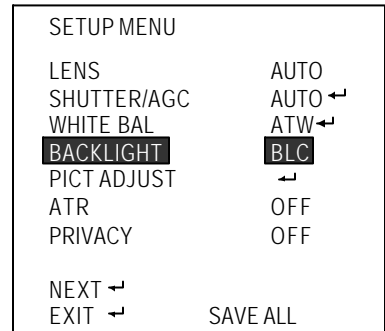

## PICT ADJUST (PICTURE ADJUST)

1. Select [PICT ADJUST] option and press "SET" button. The PICT ADJUST menu appears.
2. Push ◀ or ▶ button to select a mode or set the function level(000~255).

PICT ADJUST mode changes as follows:

▶ MIRROR BRIGHTNESS CONTRAST ◀  
◀ GAIN HUE SHARPNESS ◀

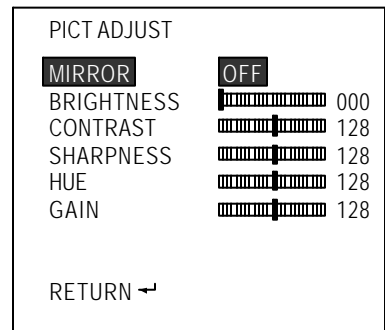

FUNCTION	OPTION	DESCRIPTION
MIRROR	OFF ON	Sets the horizontal flip for the display output. OFF: Normal output. ON: Horizontal flipped output
BRIGHTNESS	000~255	Sets the screen brightness.
CONTRAST	000~255	Sets the screen contrast.
SHARPNESS	000~255	Sets the screen sharpness.
HUE	000~255	Adjusts the hue.
GAIN	000~255	Adjusts the gain.

## ATR (Adaptive Tone Reproduction)

The ATR(Adaptive Tone Reproduction) function provides gradation compensation to improve the contrast of subjects whose gradation has been lost in cases where, for instance, both low-luminance areas and high-luminance areas exist in the same picture.

1. Select [ATR] option.
2. Push◀or▶button to select a ON and press "SET" button. The ATR menu appears.
3. Push◀or▶button to set the luminance level and contrast level.

LUMINANCE level changes as follows:

▶LOW MID HIGH ◀

CONTRAST level changes as follows:

▶LOW MIDLOW MID MIDHIGH HIGH ◀

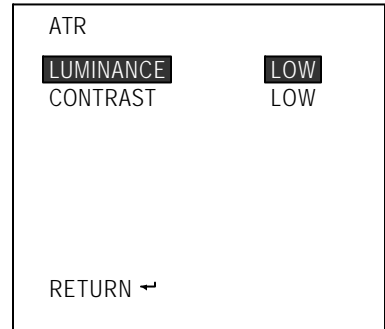

FUNCTION	OPTION	DESCRIPTION
LUMINANCE	LOW MID HIGH	Sets the extent of the luminance compression.
CONTRAST	LOW MIDLOW MID MIDHIGH HIGH	Sets the extent of the contrast enhancement.

## PRIVACY

This function is used to set up to eight privacy masks.

1. Select [PRIVACY] option.
2. Push◀or▶button to select a ON and press "SET" button. The PRIVACY menu appears.
3. Push◀or▶button to select a mode or set the mask frame position.

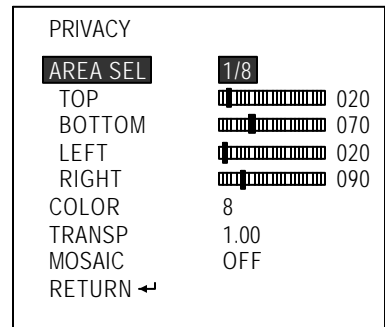

FUNCTION	OPTION	DESCRIPTION
AREA SEL	1/8, 2/8, 3/8, 4/8, 5/8, 6/8, 7/8, 8/8	Selects the mask frame to be adjusted.
TOP	000~244(NTSC) 000~288(PAL)	Sets the top side of the mask frame selected by the AREA SEL parameter.
BOTTOM	000~244(NTSC) 000~288(PAL)	Sets the bottom side of the mask frame selected by the AREA SEL parameter.
LEFT	000~474(NTSC) 000~468(PAL)	Sets the left side of the mask frame selected by the AREA SEL parameter.
RIGHT	000~474(NTSC) 000~468(PAL)	Sets the right side of the mask frame selected by the AREA SEL parameter.
COLOR	1~8	Sets the colors of the mask frames.
TRANSP	0.00 0.50 0.75 1.00	Sets the transparency ratio of the mask frames. The same transparency ratio value is set for all the mask frames.
MOSAIC	OFF ON	Sets the mask frame mosaic function to ON or OFF. OFF: Mosaic function OFF. ON: Mosaic function ON.

## NR (Noise Reduction)

This function is used to set the noise reduction.

1. Select [NR] option and press "SET" button.  
The NR menu appears.
2. Push ◀ or ▶ button to select one of four modes for NR or set the different filter strength.  
NR mode changes as follows:

▶ Y/C OFF Y C ◀

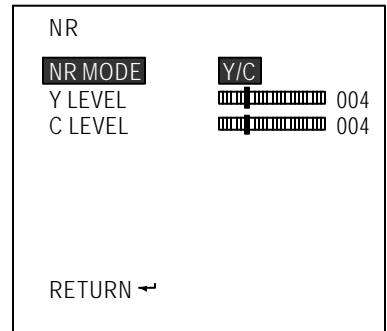

FUNCTION	OPTION	DESCRIPTION
NR MODE	Y/C OFF Y C	Sets the 2D NR filter mode. Y/C: Y and C filters ON. OFF: Through Y: Y filter ON. C: C filter ON.
Y LEVEL	000~015	Sets the Y filter strength.
C LEVEL	000~015	Sets the C filter strength.

## CAMERA ID

This function is used to set the camera ID.

1. Select [CAMERA ID] option.
2. Use◀or▶ button to select a ON and press "SET" button. The CAMERA ID menu appears.

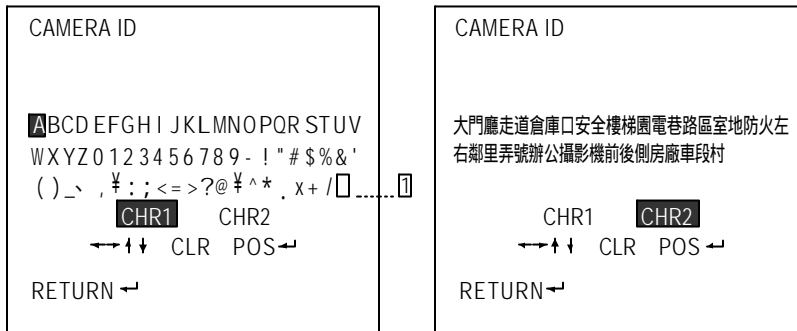

3. Use▲,▼,◀or▶ button to select a letter, numeral or symbol.
  - \* [ ] (Blank): Inserts a space at the cursor position.
  - \* CHR1: Letters A to Z, numerals 0 to 9, symbols.
  - \* CHR2: 40 traditional Chinese.
  - \* ← → ↑ ↓: Moves cursor to left, right, up or down.
  - \* CLR: If you enter the wrong code, select CLR then press "SET" button.
  - \* POS: Use ▲, ▼, ◀ or ▶ button to move position of CAMERA ID on the screen.

## SYNC

This function is used to display the current synchronization mode. The SYNC mode is fixed to the INT(Internal synchronization).

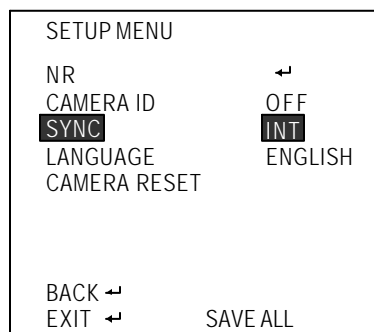

## LANGUAGE

This function is used to select the language in which to display the internal OSD menu.

1. Select [LANGUAGE] option.
2. Push◀ or ▶ button to select a language.

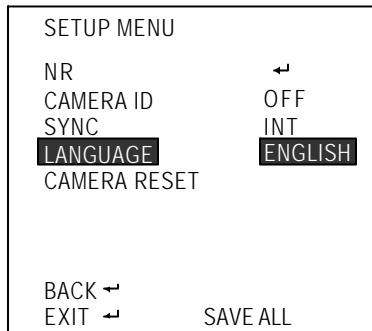

## CAMERA RESET

This function initializes all the internal OSD menu settings together.

1. Select [CAMERA RESET] option.
2. Press "SET" button to reset the camera setting to initial setting.
3. Select [SAVE ALL] option on the [SETUP MENU] menu. Press "SET" button.

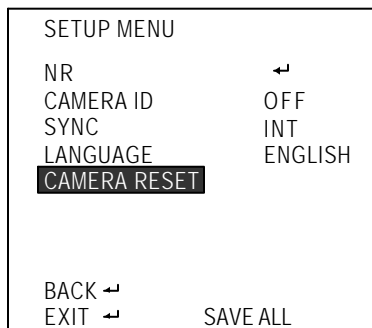

# SPECIFICATIONS

D/N ATR 700TVL VARI-FOCAL IR CAMERA			
Model No.		CMR7384X10N/P	CMR7388X10N/P
Lens	Focal Length		5 ~ 50mm
	Iris		F1.4
	Angle of view	H	51.5 °~ 6.5 °
		V	37.5 °~ 5.0 °
D		65 °~ 8.1 °	
Power Input Voltage		AC24V ( ±0%)	AC100~240V
System		NTSC or PAL	
Pick Up Element		1/3" Exview HAD CCD Sensor	
Effective Pixels		976(H) x 494(V) [NTSC] 976(H) x 582(V) [PAL]	
Chip Size		5.58mm(H) x 4.67mm(V)	
Horizontal & Vertical Sync. Frequency		15.734 KHz / 59.94Hz [NTSC] 15.625 KHz / 50Hz [PAL]	
Scanning System		2:1 Interlace	
Menu Control		OSD Control	
Sync. Mode		Internal	
Infrared Cut Filter		Auto Selectable, Automatic Switch From Color Mode to Monochrome	
Resolution		Color: 700TV Lines, Mono: 750TV Lines	
Minimum Illumination	Color	0.045Lux / F1.4	
	Mono	0.009Lux / F1.4	
	IR On	0Lux	
S/N Ratio		More Then 50dB (AGC-OFF)	
Auto Gain Control		AUTO / MANUAL	
White Balance		ATW / PUSH / USER1 / USER2 / ANTI CR / MANUAL / PUSH LOCK	
Shutter	Auto	1/60(1/50)S ~ 1/100,000S	
	Manual	1/60(1/50)S, 1/100(1/120)S, 1/250S, 1/500S, 1/1,000S, 1/2,000S, 1/4,000S, 1/10,000S	
Adaptive Tone Reproduction	Luminance	LOW / MID / HIGH	
	Contrast	LOW / MIDLOW / MID / MIDHIGH / HIGH	
Back Light Compensation		BLC / HLC(High Light Compensation) / OFF	
Noise Reduction		Y / C / Y/C / OFF	
Picture Adjust		MIRROR / BRIGHTNESS / CONTRAST / SHARPNESS / HUE / GAIN	
Privacy Masking		ON / OFF	
Privacy Masking Zone		8 Zones	
OSD Language		ENGLISH/JAPANESE/GERMANS/FRENCH/RUSSIAN/PORTUGUESE/SPANISH/SIMPLY CHINESE	
Video Output		CVBS 1.0Vp-p, 75ohm	
Gamma Characteristic		=0.45	
Power Consumption		22W	
Operating Temperature		-10 ~ +50 (14 ~ 122 )	
IP Rating		IP66	
Window		110 Heat Resistant Glass	
Blower Control		On: 35 , Off: 25	
Heater Control		On: 15 , Off: 25	
Infrared LED	Peak Wavelength	850nm	
	Beam Spread	10 ± 30 °	
	Radiant Distance	100M	
Dimension		Body:146mm(W) x 154mm(H) x 374mm(D), Bracket: 211.5mm(L)	
Weight		3700g	

Design and specifications are subject to change without notice.



MERIT LILIN ENT. CO., LTD  
<http://www.meritlilin.com>

66-CMR738CSE